

BIPOLAR DIGITAL INTEGRATED CIRCUIT

μ PB1509GV

1GHz INPUT DIVIDE BY 2, 4, 8 PRESCALER IC FOR PORTABLE SYSTEMS

μ PB1509GV is a divide by 2, 4, 8 prescaler IC for portable radio or cellular telephone applications. μ PB1509GV is a shrink package version of μ PB587G so that this small package contributes to reduce the mounting space.

μ PB1509GV is manufactured using NEC's high fr NESAT™ IV silicon bipolar process. This process uses silicon nitride passivation film and gold electrodes. These materials can protect chip surface from external pollution and prevent corrosion/migration. Thus, this IC has excellent performance, uniformity and reliability.

FEATURES

- High toggle frequency : $f_{in} = 50 \text{ MHz to } 700 \text{ MHz @ } \div 2,$
50 MHz to 800 MHz @ $\div 4,$
50 MHz to 1000 MHz @ $\div 8$
- Low current consumption : 5.0 mA @ $V_{cc} = 3.0 \text{ V}$
- High-density surface mounting : 8 pin plastic SSOP (175mil)
- Supply voltage : $V_{cc} = 2.2 \text{ to } 5.5 \text{ V}$
- Selectable division : $\div 2, \div 4, \div 8$

APPLICATION

- Portable radio systems
- Cellular/cordless telephone 2nd Local prescaler and so on.

ORDERING INFORMATION

PART NUMBER	PACKAGE	MARKING	SUPPLYING FORM
μ PB1509GV-E1	8 pin plastic SSOP (175 mil)	1509	Embossed tape 8 mm wide. Pin 1 is in tape pull-out direction. 1000p/reel.

Remarks : To order evaluation samples, please contact your local NEC sales office. (Part number for sample order: μ PB1509GV)

Caution:Electro-static sensitive devices

PIN CONNECTION (Top View)

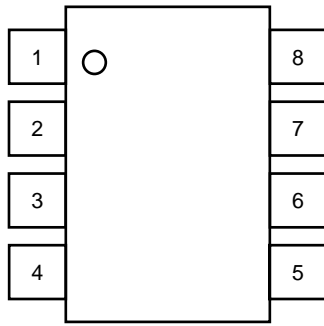

Pin NO.	Pin Name
1	V _{CC1}
2	IN
3	$\overline{\text{IN}}$
4	GND
5	SW1
6	SW2
7	OUT
8	V _{CC2}

PRODUCT LINE-UP

Product No.	I _{CC} (mA)	V _{CC} (V)	÷ 2 f _{in} (MHz)	÷ 4 f _{in} (MHz)	÷ 8 f _{in} (MHz)	Package	Pin Connection
μPB587 G	5.5	2.2 to 3.5	50 to 300	50 to 600	50 to 1000	8 pin SOP (225 mil)	NEC Original
μPB1509 GV	5.0	2.2 to 5.5	50 to 700	50 to 800	50 to 1000	8 pin SSOP (175 mil)	

Remarks

This table shows the TYP values of main parameters. Please refer to ELECTRICAL CHARACTERISTICS.

μPB587G is discontinued.

INTERNAL BLOCK DIAGRAM

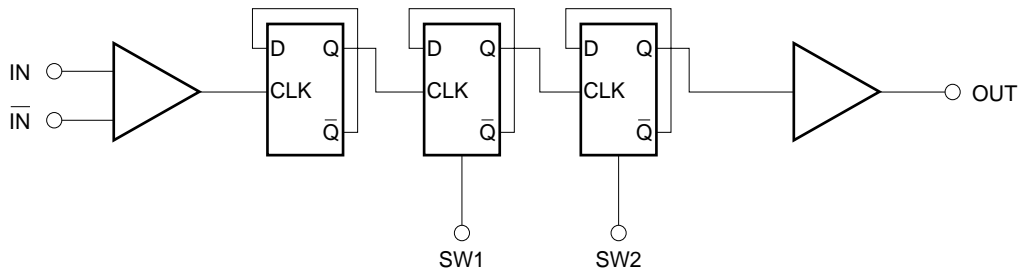

SYSTEM APPLICATION EXAMPLE

One of the example for usage

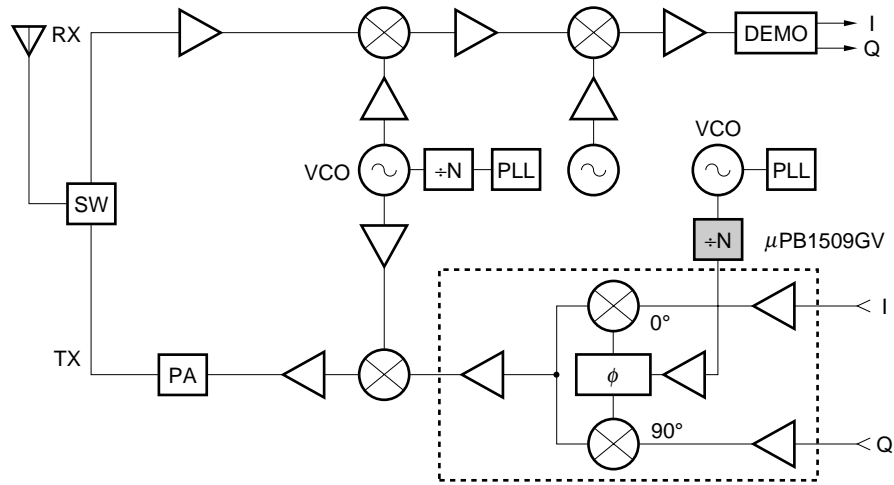

This block diagram schematically shows the μ PB1509GV's location in one of the example application system. The other applications are also acceptable for divider use.

Pin Explanations

Pin No.	Symbol	Applied Voltage	Pin Voltage	Functions and Explanation													
1	V _{CC1}	2.2 to 5.5	—	Power supply pin of a input amplifier and dividers. This pin must be equipped with bypass capacitor (eg 1000 pF) to minimize ground impedance.													
2	IN	—	1.7 to 4.95	Signal input pin. This pin should be coupled to signal source with capacitor (eg 1000 pF) for DC cut.													
3	\bar{IN}	—	1.7 to 4.95	Signal input bypass pin. This pin must be equipped with bypass capacitor (eg 1000 pF) to minimize ground impedance.													
4	GND	0	—	Ground pin. Ground pattern on the board should be formed as wide as possible to minimize ground impedance.													
5	SW1	H/L	—	Divide ratio control pin. Divide ratio can be determined by following applied level to these pins. <table border="1" style="margin: 10px auto;"> <thead> <tr> <th colspan="2" rowspan="2"></th> <th colspan="2">SW2</th> </tr> <tr> <th>H</th> <th>L</th> </tr> </thead> <tbody> <tr> <th rowspan="2">SW1</th> <th>H</th> <td>1/2</td> <td>1/4</td> </tr> <tr> <th>L</th> <td>1/4</td> <td>1/8</td> </tr> </tbody> </table>			SW2		H	L	SW1	H	1/2	1/4	L	1/4	1/8
		SW2															
		H	L														
SW1	H	1/2	1/4														
	L	1/4	1/8														
6	SW2	H/L	—	These pins must be each equipped with bypass capacitor to minimize their impedance.													
7	OUT	—	1.0 to 4.7	Divided frequency output pin. This pin is designed as emitter follower output. This pin can output 0.1 V _{P-P} min with 200 Ω load. This pin should be coupled to load device with capacitor (eg 1000 pF) for DC cut.													
8	V _{CC2}	2.2 to 5.5	—	Power supply pin of output buffer amplifier. This pin must be equipped with bypass capacitor (eg 1000 pF) to minimize ground impedance.													

ABSOLUTE MAXIMUM RATINGS

PARAMETER	SYMBOL	CONDITION	RATINGS	UNIT
Supply voltage	V _{CC}	T _A = +25 °C	6.0	V
Input voltage	V _{in}	T _A = +25 °C, SW1, SW2 pins	6.0	V
Total power dissipation	P _D	Mounted on double sided copper clad 50 × 50 × 1.6 mm epoxy glass PWB (T _A = +85 °C)	250	mW
Operating ambient temperature	T _A		-40 to +85	°C
Storage temperature	T _{stg}		-55 to +150	°C

RECOMMENDED OPERATING CONDITIONS

PARAMETER	SYMBOL	MIN.	TYP.	MAX.	UNIT	NOTICE
Supply voltage	V _{CC}	2.2	3.0	5.5	V	
Operating ambient temperature	T _A	-40	+25	+85	°C	

ELECTRICAL CHARACTERISTICS (T_A = -40 to +85 °C, V_{CC} = 2.2 to 5.5 V)

PARAMETERS	SYMBOLS	TEST CONDITIONS	MIN.	TYP.	MAX.	UNIT
Circuit current	I _{CC}	No signals, V _{CC} = 3.0 V	3.5	5.0	5.9	mA
Upper Limit Operating Frequency 1	f _{in(U)1}	P _{in} = -20 to 0 dBm	500	—	—	MHz
Upper Limit Operating Frequency 2	f _{in(U)2}	P _{in} = -20 to -5 dBm @ ÷ 2 @ ÷ 4 @ ÷ 8	700 800 1000	— — —	— — —	MHz
Lower Limit Operating Frequency 1	f _{in(L)1}	P _{in} = -20 to 0 dBm	—	—	50	MHz
Lower Limit Operating Frequency 2	f _{in(L)2}	P _{in} = -20 to -5 dBm	—	—	500	MHz
Input Power 1	P _{in1}	f _{in} = 50 MHz to 1000 MHz	-20	—	-5	dBm
Input Power 2	P _{in2}	f _{in} = 50 MHz to 500 MHz	-20	—	0	dBm
Output Voltage	V _{out}	R _L = 200 Ω	0.1	0.2	—	V _{P-P}
Divide ratio control input high	V _{IH1}	Connection in the test circuit	V _{CC}	V _{CC}	V _{CC}	—
Divide ratio control input low	V _{IL1}	Connection in the test circuit	OPEN or GND	OPEN or GND	OPEN or GND	—
Divide ratio control input high	V _{IH2}	Connection in the test circuit	V _{CC}	V _{CC}	V _{CC}	—
Divide ratio control input low	V _{IL2}	Connection in the test circuit	OPEN or GND	OPEN or GND	OPEN or GND	—

TEST CIRCUIT

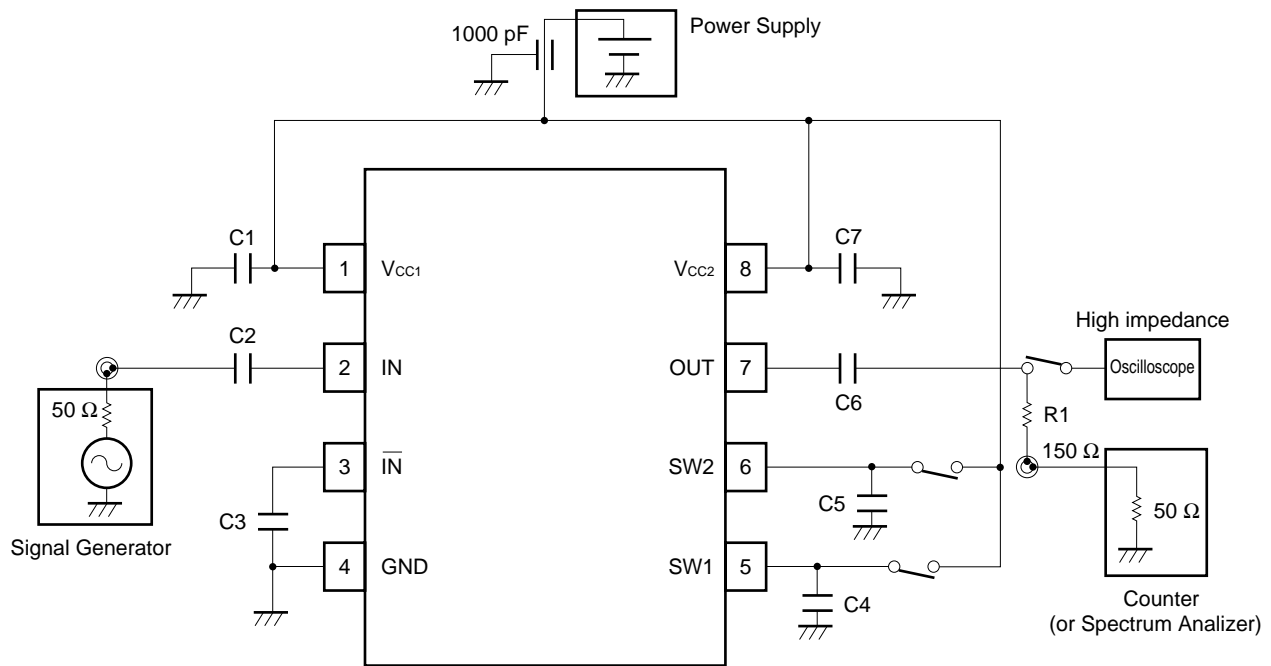

EQUIPMENTS

Signal Generator (HP-8665A)

Counter (HP-5350B) for measuring input sensitivity (Spectrum Analyzer for measuring output frequency)

Oscilloscope for measuring output swing (In measuring output power on Spectrum Analyzer, oscilloscope should be turned off.)

Divide Ratio Setting

		SW2	
		H	L
SW1	H	1/2	1/4
	L	1/4	1/8

H: SW pin should be connected to Vcc1 pin.

L: SW pin should be opened or connected to GND.

ILLUSTRATION OF THE TEST CIRCUIT ASSEMBLED ON EVALUATION BOARD

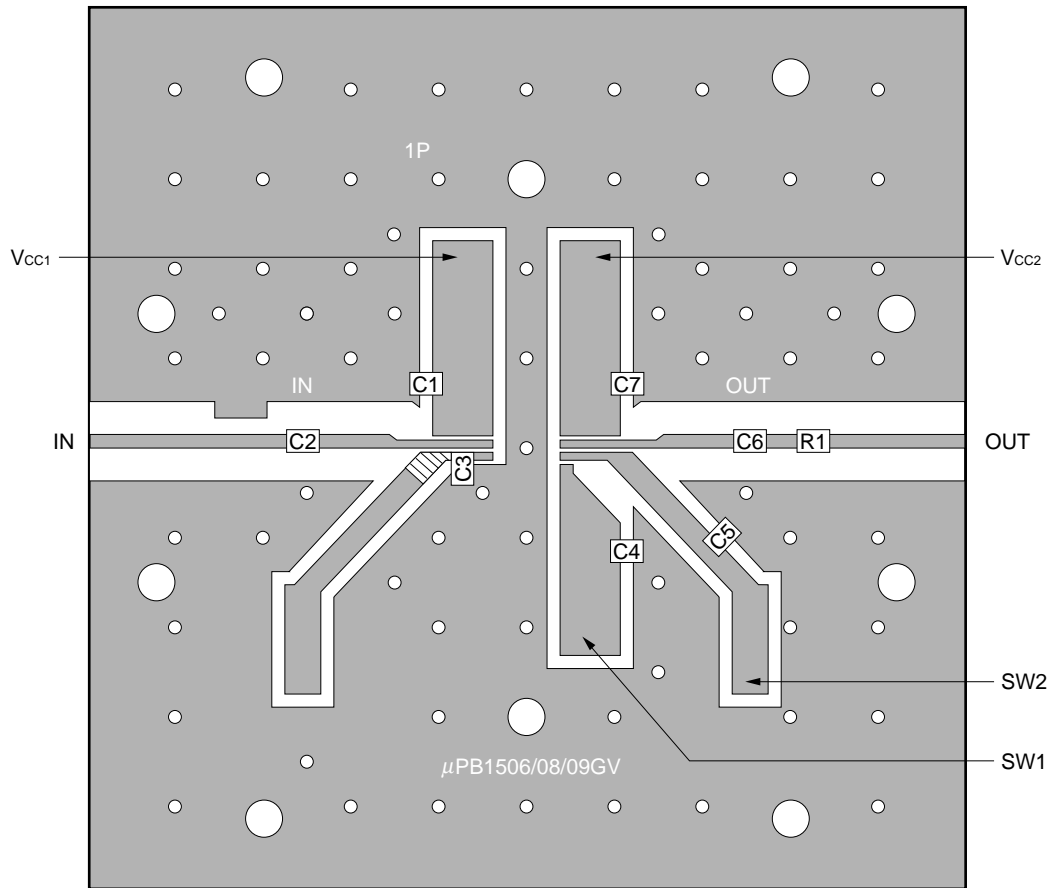

Component List

No.	Value
C1 to C7	1000 pF
R1	150 Ω ^{Note}

Notes for evaluation board

- (1) 35 μm thick double sided copper clad 50 × 50 × 0.4 mm polyimide board
- (2) Back side : GND pattern
- (3) Solder plated on pattern
- (4) ○ : Through holes
- (5) ▨ : Remove pattern

Note For Output load of IC, R1 is determined as follows; R1 + Impedance of measurement equipment = 200 Ω.

The application circuits and their parameters are for reference only and are not intended for use in actual design-ins.

The usage and applications of μPB1509GV should be referred to the application note (Document No. P12611E).

CHARACTERISTIC CURVES

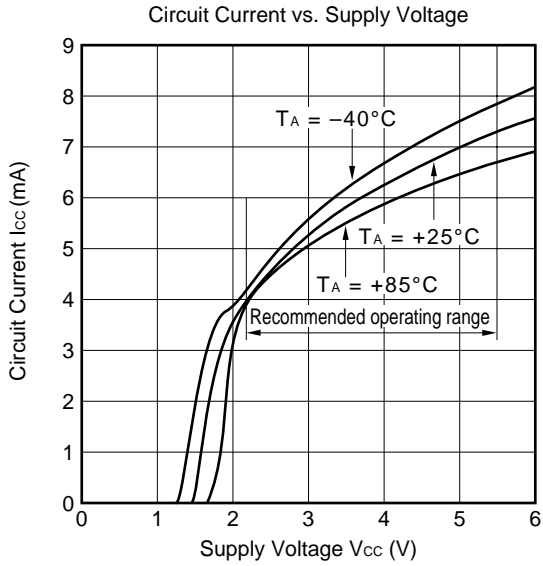

Divide by 2 mode (Guaranteed operating window: $V_{CC} = 2.2$ to 5.5 V , $T_A = -40$ to $+85^\circ\text{C}$)

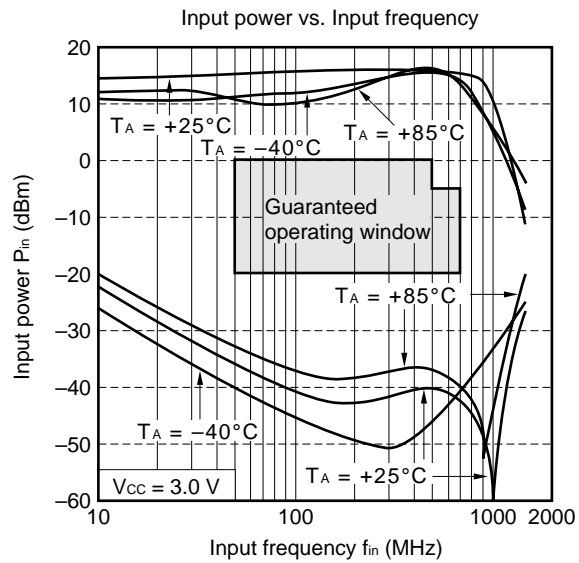
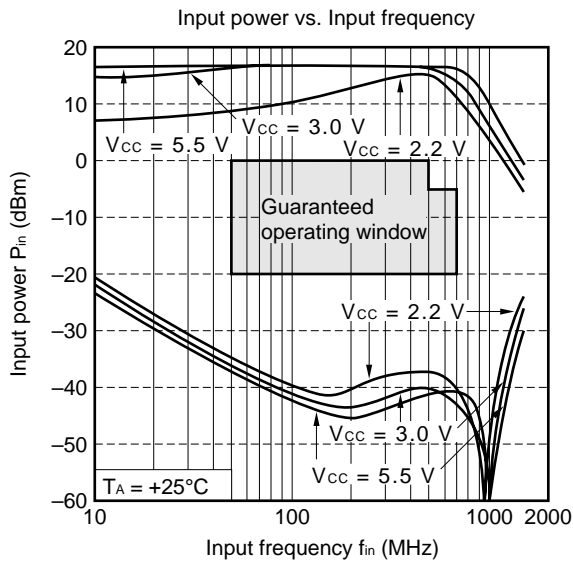

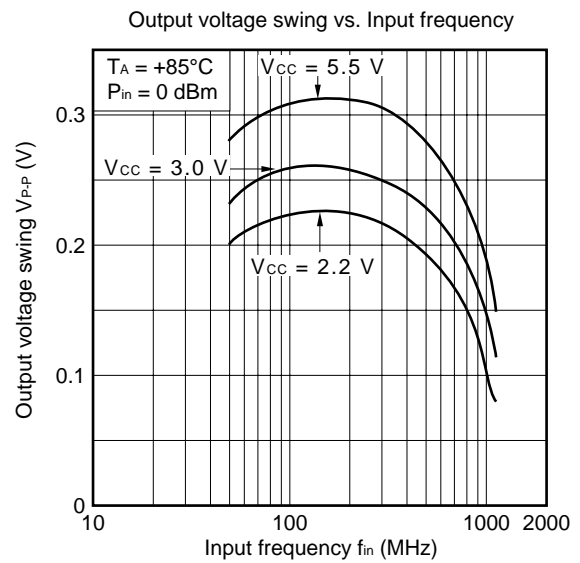
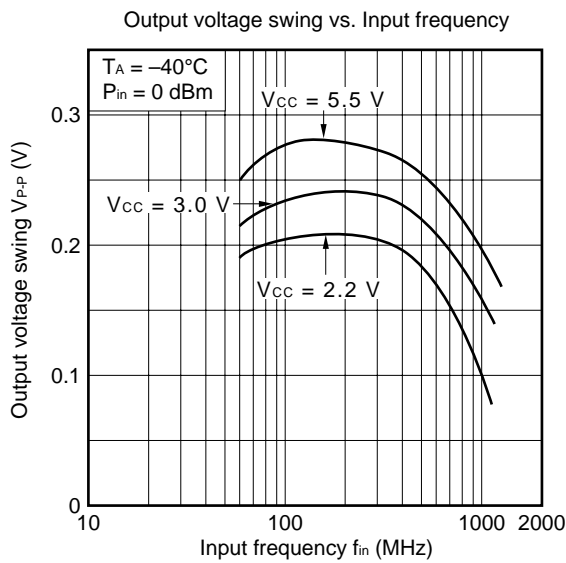
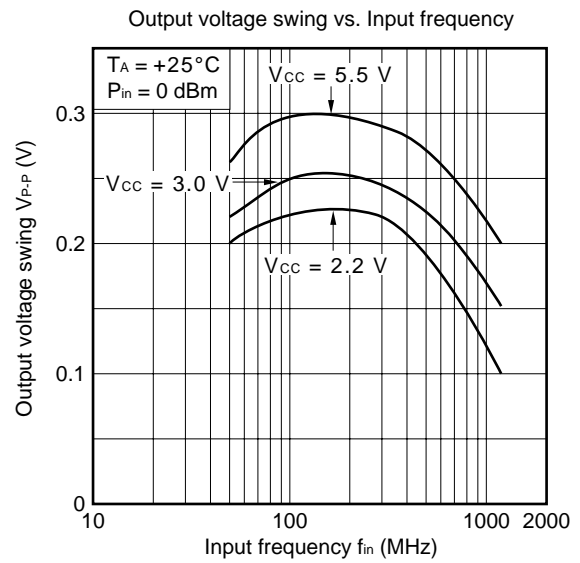
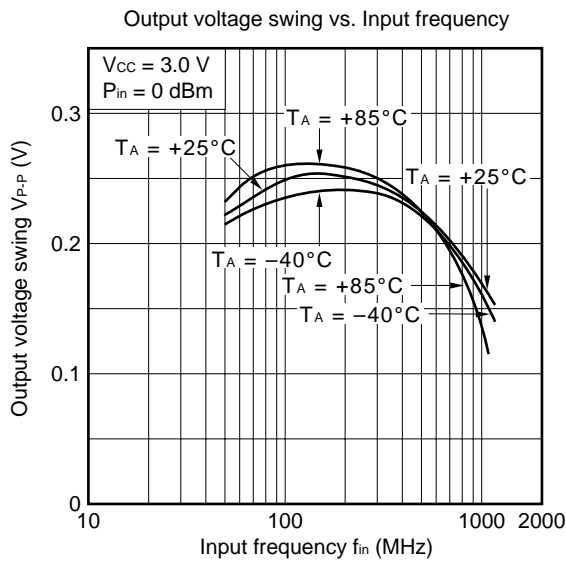
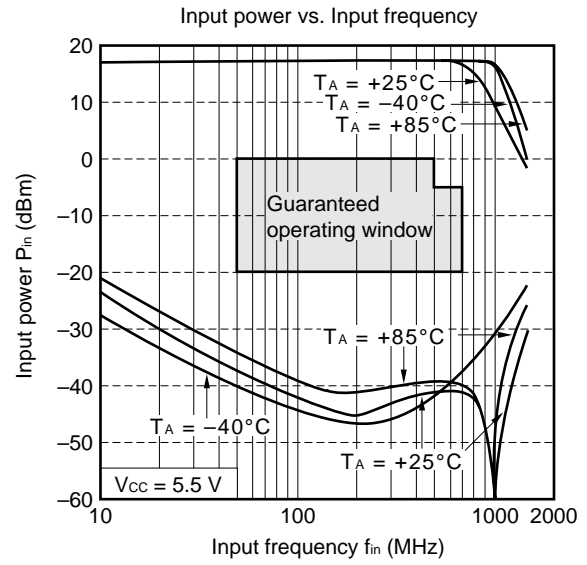
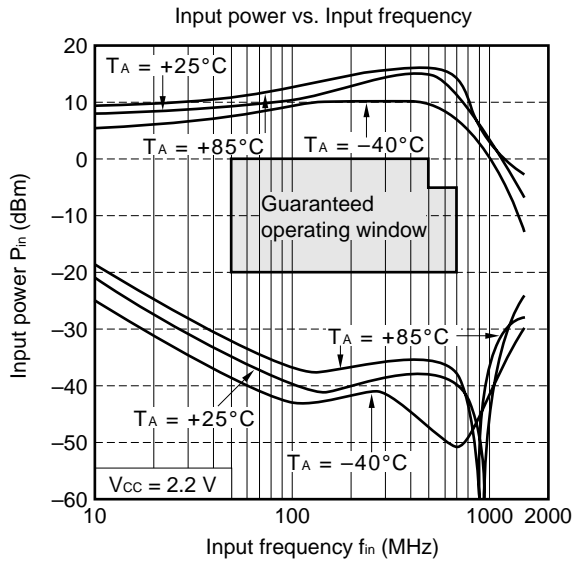

Divide by 4 mode (Guaranteed operating window: $V_{CC} = 2.2$ to 5.5 V, $T_A = -40$ to $+85^\circ\text{C}$)

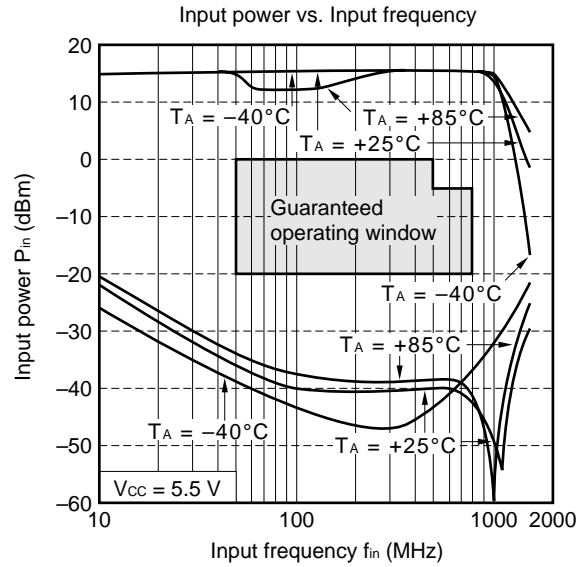
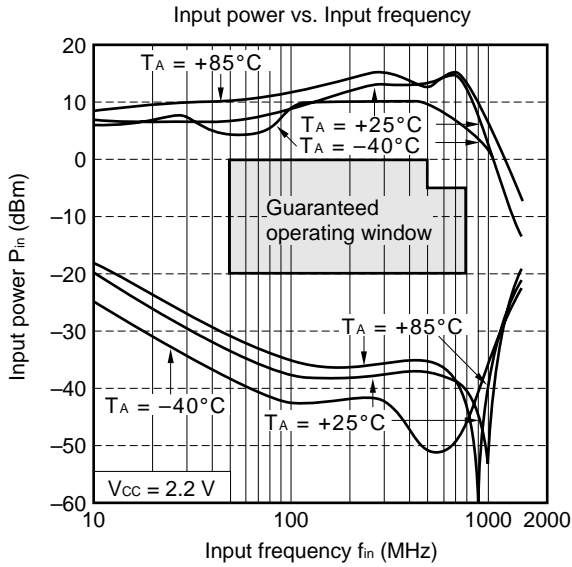
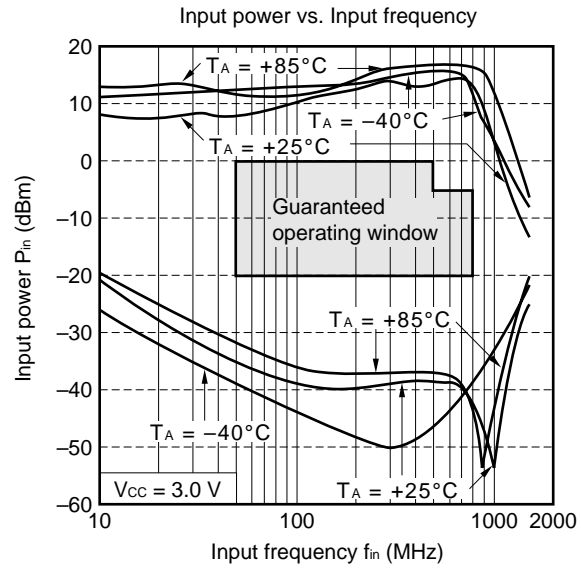
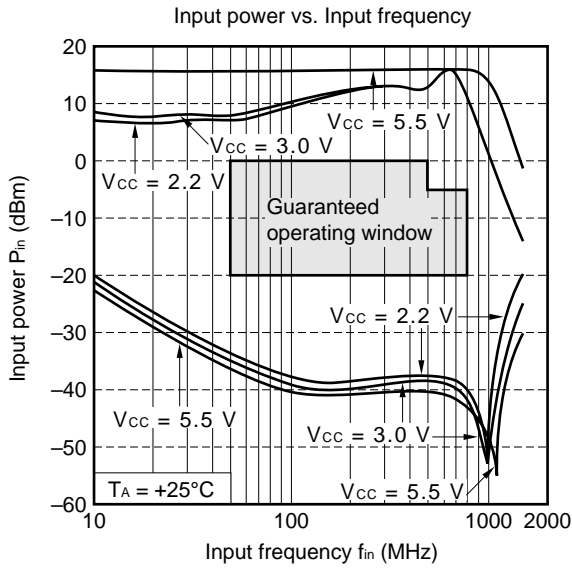

Divide by 8 mode (Guaranteed operating window: $V_{CC} = 2.2$ to 5.5 V, $T_A = -40$ to $+85^\circ\text{C}$)

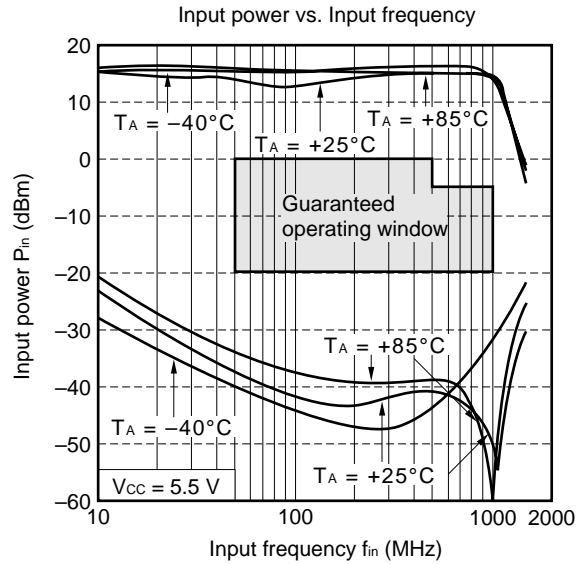
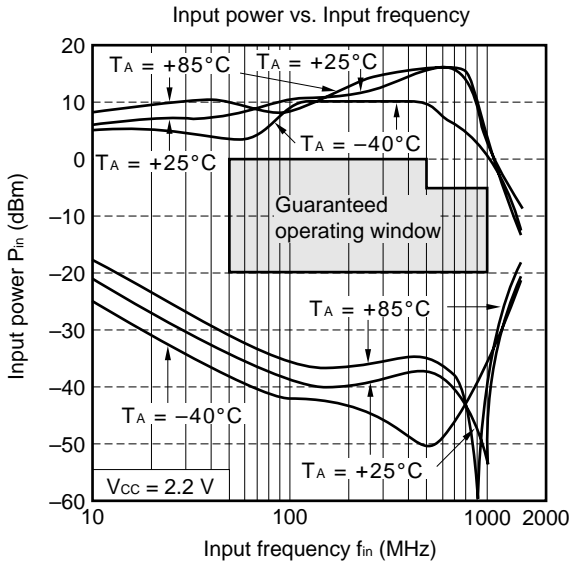
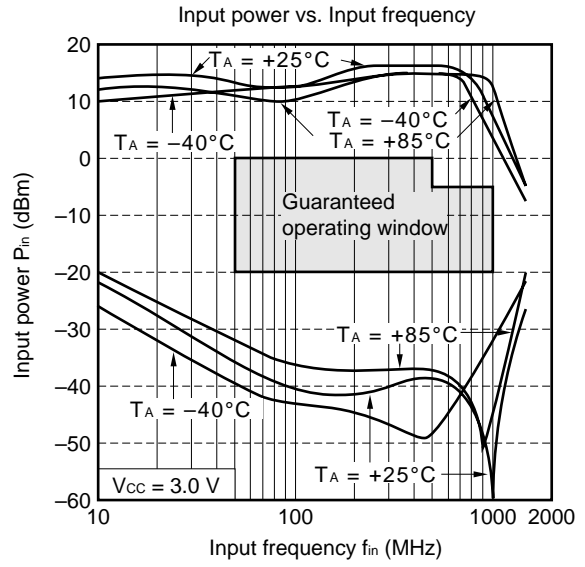
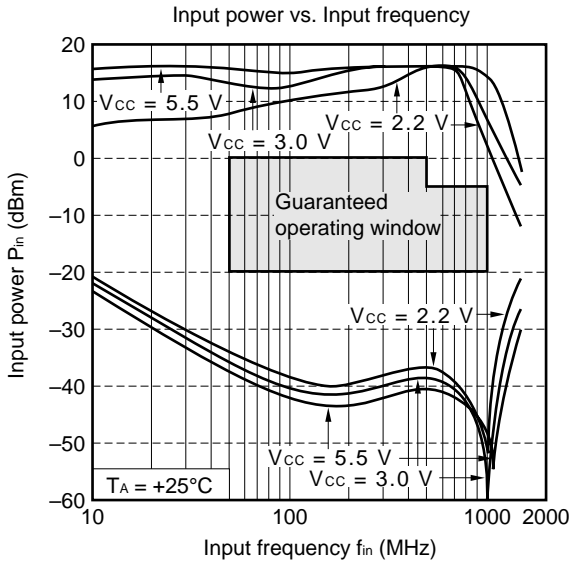

S₁₁ vs. Input Frequency

S₁₁
 REF 1.0 Units/
 2 200.0 mUnits/
 ▽ 55.375 Ω - 142.79 Ω

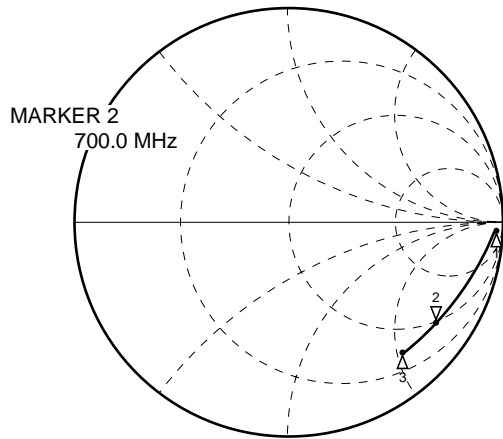

START 0.050000000 GHz
 STOP 1.000000000 GHz

V_{CC1} = V_{CC2} = 3.0 V, SW1 = SW2 = 3.0 V

FREQUENCY MHz	S ₁₁ MAG	ANG
100.0000	.929	-6.7
200.0000	.898	-10.5
300.0000	.866	-13.6
400.0000	.840	-15.9
500.0000	.834	-19.1
600.0000	.819	-21.9
700.0000	.803	-24.7
800.0000	.792	-27.0
900.0000	.787	-30.0
1000.0000	.771	-32.7

S₂₂ vs. Output Frequency

S₂₂
 REF 1.0 Units/
 200.0 mUnits/

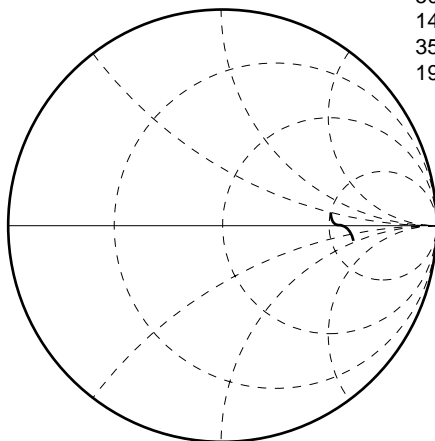

START 0.050000000 GHz
 STOP 0.350000000 GHz

Z
 50 MHz
 149.09 Ω + j 14.86 Ω
 350 MHz
 194.21 Ω - j 36.64 Ω

PACKAGE DIMENSIONS (UNIT: mm)

8 PIN PLASTIC SSOP (175 mil)

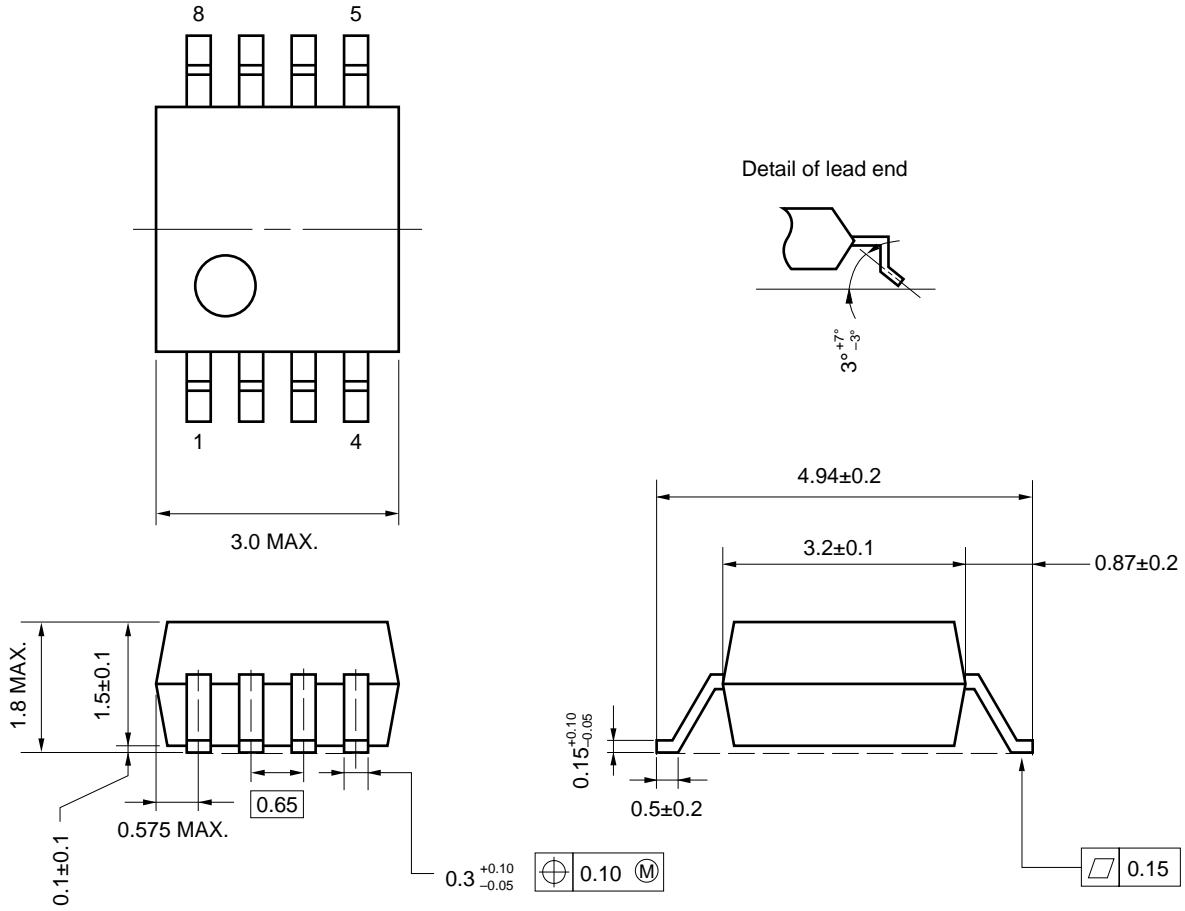

NOTE ON CORRECT USE

- (1) Observe precautions for handling because of electro-static sensitive devices.
- (2) Form a ground pattern as wide as possible to minimize ground impedance (to prevent undesired operation).
- (3) Keep the wiring length of the ground pins as short as possible.
- (4) Connect a bypass capacitor (e.g. 1000 pF) to the V_{CC} pin.

RECOMMENDED SOLDERING CONDITIONS

This product should be soldered in the following recommended conditions. Other soldering methods and conditions than the recommended conditions are to be consulted with our sales representatives.

μPB1509GV

Soldering method	Soldering conditions	Recommended condition symbol
Infrared ray reflow	Package peak temperature: 235°C, Hour: within 30 s. (more than 210°C), Time: 3 times, Limited days: no.*	IR35-00-3
VPS	Package peak temperature: 215°C, Hour: within 40 s. (more than 200°C), Time: 3 times, Limited days: no.*	VP15-00-3
Wave soldering	Soldering tub temperature: less than 260°C, Hour: within 10 s. Time: 1 time, Limited days: no.	WS60-00-1
Pin part heating	Pin area temperature: less than 300°C, Hour: within 3 s./pin Limited days: no.*	

* It is the storage days after opening a dry pack, the storage conditions are 25°C, less than 65% RH.

Caution The combined use of soldering method is to be avoided (However, except the pin area heating method).

For details of recommended soldering conditions for surface mounting, refer to information document SEMICONDUCTOR DEVICE MOUNTING TECHNOLOGY MANUAL (C10535E).

[MEMO]



ATTENTION

OBSERVE PRECAUTIONS
FOR HANDLING
ELECTROSTATIC
SENSITIVE
DEVICES

No part of this document may be copied or reproduced in any form or by any means without the prior written consent of NEC Corporation. NEC Corporation assumes no responsibility for any errors which may appear in this document.

NEC Corporation does not assume any liability for infringement of patents, copyrights or other intellectual property rights of third parties by or arising from use of a device described herein or any other liability arising from use of such device. No license, either express, implied or otherwise, is granted under any patents, copyrights or other intellectual property rights of NEC Corporation or others.

While NEC Corporation has been making continuous effort to enhance the reliability of its semiconductor devices, the possibility of defects cannot be eliminated entirely. To minimize risks of damage or injury to persons or property arising from a defect in an NEC semiconductor device, customers must incorporate sufficient safety measures in its design, such as redundancy, fire-containment, and anti-failure features.

NEC devices are classified into the following three quality grades:

"Standard", "Special", and "Specific". The Specific quality grade applies only to devices developed based on a customer designated "quality assurance program" for a specific application. The recommended applications of a device depend on its quality grade, as indicated below. Customers must check the quality grade of each device before using it in a particular application.

Standard: Computers, office equipment, communications equipment, test and measurement equipment, audio and visual equipment, home electronic appliances, machine tools, personal electronic equipment and industrial robots

Special: Transportation equipment (automobiles, trains, ships, etc.), traffic control systems, anti-disaster systems, anti-crime systems, safety equipment and medical equipment (not specifically designed for life support)

Specific: Aircrafts, aerospace equipment, submersible repeaters, nuclear reactor control systems, life support systems or medical equipment for life support, etc.

The quality grade of NEC devices is "Standard" unless otherwise specified in NEC's Data Sheets or Data Books. If customers intend to use NEC devices for applications other than those specified for Standard quality grade, they should contact an NEC sales representative in advance.

Anti-radioactive design is not implemented in this product.